

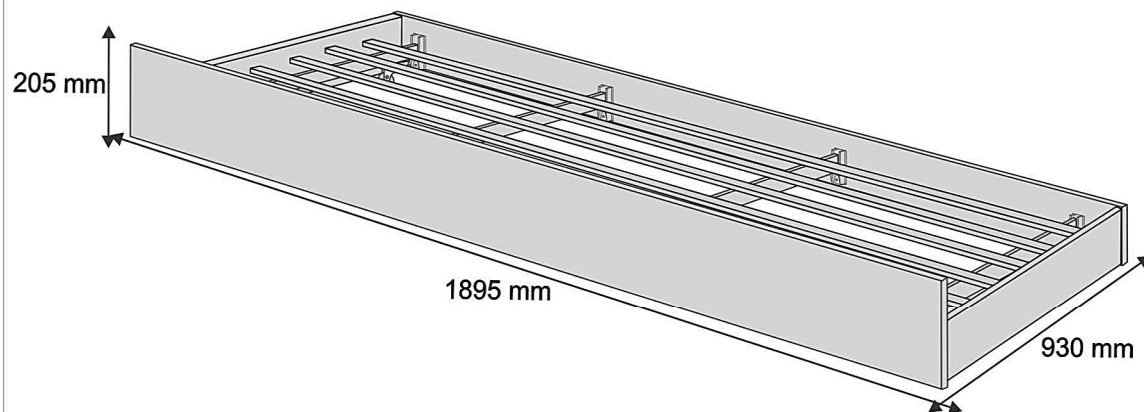







## Cama Auxiliar 0,88 DANI

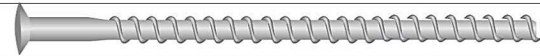

LISTA DE ACESSÓRIOS			Qt.
Nº	Acessórios		
A	Parafuso 3,5 x 16mm		08
B	Parafuso 7,0 x 70mm		08
C	Tampa 17 mm		08
D	Chave Reta 50x4 mm		01
E	Prego 12 x 12mm		50
F	Rodízio 48x32x22		04
G	Suporte 65x32x26		08
H	Parafuso 4,5x50mm		08

Cód Pç	Branco	Cinza	Tabaco	Imbuia	Descrição	Medida	Mat Pr	Qtd
01	1.8	1.18	1.7	1.12	Barra Lateral	900x90x15	MDF	02
02	2.8	2.18	2.7	2.12	Barra Frontal	1895x205x15	MDF	01
03	3.8	3.18	3.7	3.12	Barra Traseira	1895x115x15	MDF	01
04	4.8	4.18	4.7	4.12	Sarrafo	895x45x25	MAD	04
05					Ripa	1850x70x10	PINOS	06
06					Kit Ferragens			01

Tabela de Cores	
Cód	Cor
7	Tabaco
8	Branco
12	Imbuia
18	Cinza

### DESEMBALANDO

Identifique todas as peças e deixe-as de pé, nunca coloque umas sobre as outras.

Utilize a própria embalagem como tapete para a montagem do produto.

### PARA A LIMPEZA E CONSERVAÇÃO DO SEU MÓVEL

- Não use produtos abrasivos como Álcool, Solventes, Acetona e etc...
- Use somente um pano macio e seco.